

MODEL 62000D SERIES

KEY FEATURES

- Voltage rating : 0~100V/600V/1200V/1800V
- Current rating : 0~540A
- Power rating : 6kW/12kW/18kW
- Two-quadrant operation: source and load functions
- High power density: 18kW in 3U
- Easy master/slave parallel & series *1 operation up to 540kW
- Wide range of voltage & current combinations in constant power
- Auto sequencing programming
- Voltage & current slew rate control
- High speed transient response <1.5ms
- Low output noise and ripple
- Intuitive and user-friendly touch control screen
- Standard USB/LAN/APG interfaces, optional CAN/GPIB interfaces
- 3-phase 4-wire universal AC power: 200~480 Vac
- Solar array simulation function (optional)

*1: 100V/600V models support series operation.
1200V/1800V models support parallel operation up to 540kW.

APPLICATIONS

- Charge/discharge testing and life cycle testing, including BOBC, DC-DC conversion, and PCS
- Motor driver testing
- Pre-compliant with LV123 and LV148 standards on electrical car components testing
- Used as battery simulation source for microgrid applications
- Suitable for 1500V string PV inverter testing

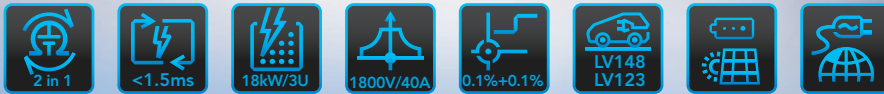

BIDIRECTIONAL DC POWER SUPPLY MODEL 62000D SERIES

Chroma 62000D programmable bidirectional DC power supplies provide both power source and load characteristics. These two quadrant power supplies allow power from the DUT to be converted back to the utility grid and so are ideal for testing renewable energy power systems such as PV, storage, and EV inverters as well as a wide range of bidirectional power conditioning system (PCS) and may also be used as a battery simulator. 62000D has applications in testing power components in electric vehicles as well as bidirectional on-board chargers (BOBC), bidirectional DC converters, and DC-AC motor drivers and can perform power conversion tests of Li-ion batteries in both charge and discharge directions.

To illustrate the 62000D unique capabilities, traditional DC power supplies need protection diodes to prevent Back EMF during motor testing does not damage the source. However, the 62000D bidirectional DC power supplies can drive the motor and also efficiently regenerate EMF to the grid, thereby avoiding the need for blocking diodes while saving space, energy, and configuration. In addition, the fast cross-quadrant bandwidth of the 62000D provides a transient response time of less than 1.5ms (-90% to +90%).

62000D bidirectional DC supplies include 9 different models with industry-leading power density at 18kW in 3U of vertical rack space. Model range from 6kW to 18kW, output current ratings up to $\pm 540A$, and voltage ratings up to 1800VDC. The master/slave feature allows for up to 10 models to be paralleled easily and safely up to 180kW.

62000D series is equipped with 100 programmable user settings through the unit's List Mode. The fast response time fills many testing needs, including the LV123 and LV148 standards required for new energy vehicle components. When combined with the Chroma Softpanel, the user can conduct the complex tests with simple clicks of the mouse.

62000D family of power supplies can easily be used in any region of the world due to its wide input range of 200-480 Vac and an active PFC low-current harmonic feed to grid, reducing power consumption, power system configuration, and ambient temperature changes under high-power testing. Control options include digital USB, LAN, CANbus, GPIB as well as analog APG interfaces.



Chroma

POWER CONVERSION TESTING OF ELECTRIC VEHICLES AND MICROGRID STORAGE

Renewable energy sources such as PV, EV, fuel cell, and battery are the market trend as the replacement of traditional energy sources (coal, oil, etc.). Yet, the subsequent rising need for electricity will actuate the faster commercialization of distributed energy storage in microgrids. The bidirectional design of power conversion devices urges battery applications to achieve high efficiency, high voltage conversion, and high power density direction, which prompts the need for battery simulation (bidirectional power supply) testing designs.

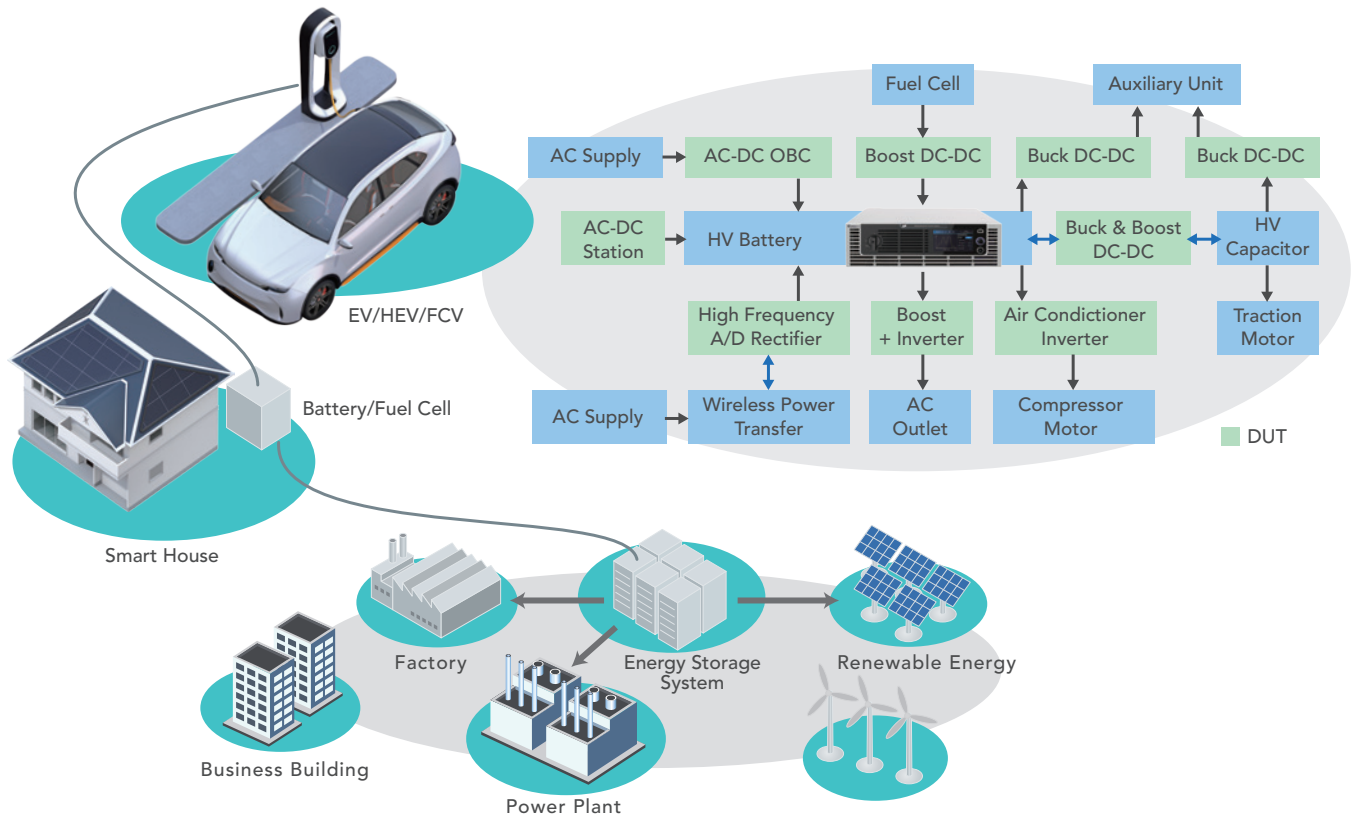

TWO-IN-ONE: BIDIRECTIONAL DC POWER SUPPLY AND LOAD

Chroma's 62000D has a bidirectional switch-mode power supply design that offers two-quadrant operation with positive current/positive voltage as well as negative current/positive voltage, enabling both DC power supply output and regenerative DC load. The absorbed energy feeds back to the grid with a conversion efficiency up to 93% and can operate in constant voltage, constant current, and constant power modes. Compared to traditional power supply and load, the 62000D two-in-one bidirectional DC power supply saves space, reduces energy loss and heat dissipation, and is easier to wire and configure.

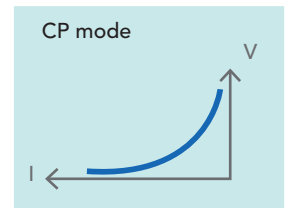
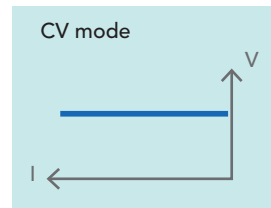
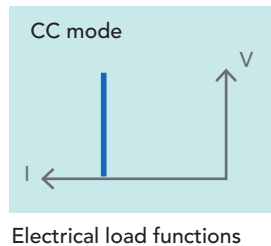
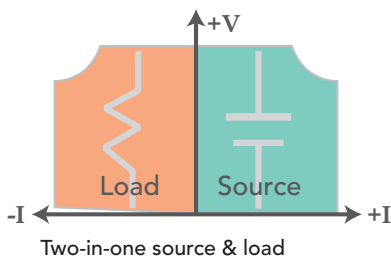

With the current evolution of electric cars, their on-board chargers are controlled through back and forth energy supply to V2G (Vehicle to Grid), V2L (Vehicle to Load), and V2H (Vehicle to Home). The regenerative load modes of the 62000D models include constant current (CC), constant voltage (CV), and constant power (CP) and simulate battery charging activity during developing and testing of the car. Where conventional methods needed one apparatus for DC power supply and another for regenerative DC load, one single Chroma 62000D can now fulfill both charging and discharging tests on its own.

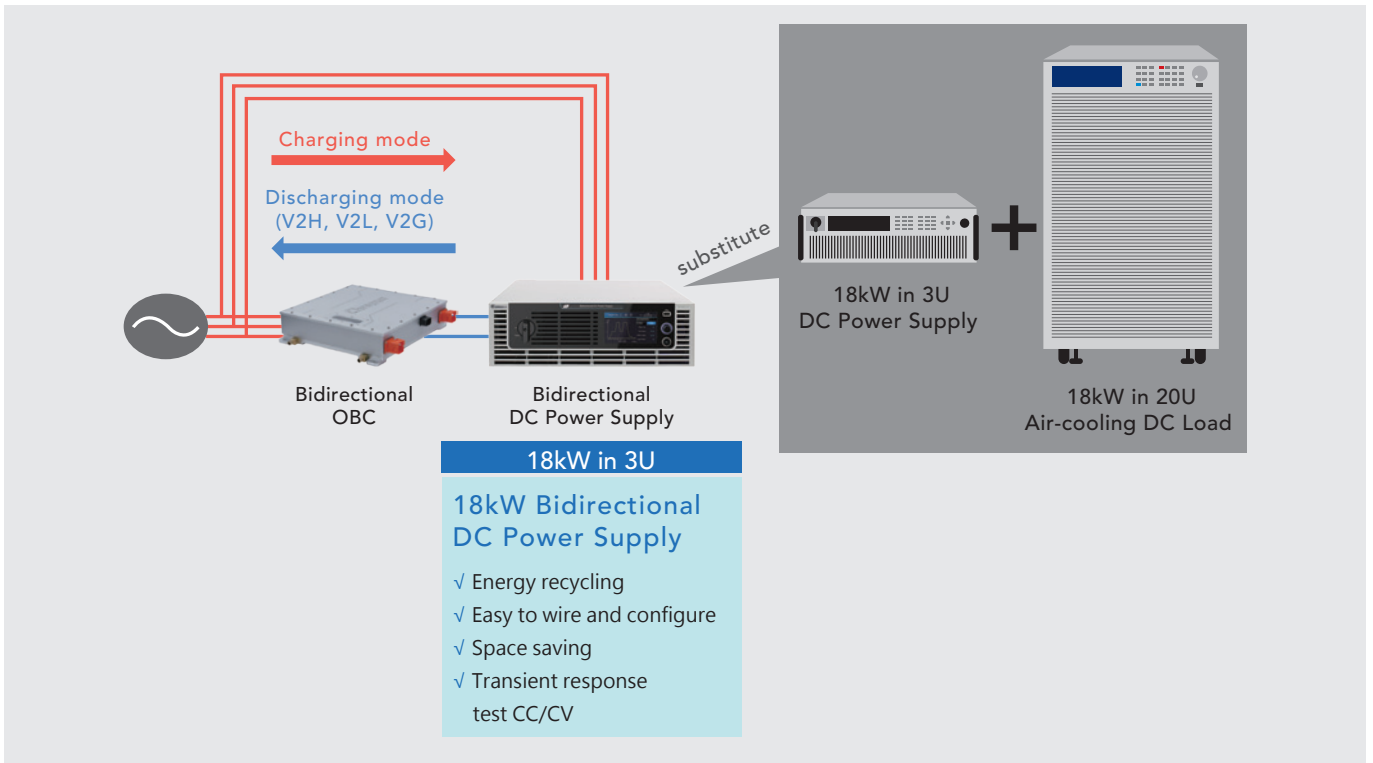

Bidirectional on-board charger testing configuration

HIGH VOLTAGE 1800V PCS TESTING

A power conditioning system (PCS) serves to realize bidirectional power conversion between the battery system and the grid with the terminal battery voltage of the newest devices reaching up to 1500V and having a charge/discharge function, active power control, reactive power regulation, and off-grid switch. A common issue for users is how to prepare an actual high voltage battery for testing the charge/discharge transition (with a standard <100ms) performance of this PCS and it is impossible to use R&D verification and manufacture with fast reproducibility, controllability, and safety. The high voltage 62180D-1800 (1800V/40A/18kW) model can be connected in parallel to reach 540kW/1800V/1200A, so replacing the real battery simulation as power supply or regenerative power load to carry out this charge/discharge transition with a seamless switch.

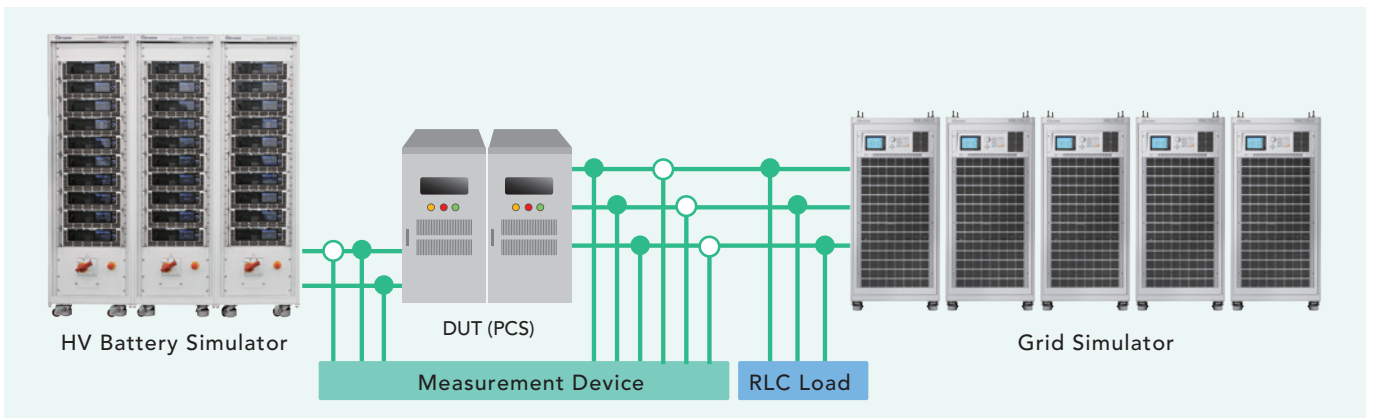

HIGH TRANSIENT RESPONSE <1.5ms

Chroma 62000D allows seamless current conversion between the two quadrants of supply and electrical load without changing the output characteristics or causing damage. To use this in many bidirectional DC-DC and DC-AC battery charge/discharge tests requires very fast charge/discharge conversion. To increase this transient responsiveness, the 62000D bidirectional DC power supply has a high speed transient response time of less than 1.5ms (-90% to +90%) and gives stable voltage output.

To test the acceleration and braking of the motor driver under driving conditions, the conversion between the battery and power components will encounter supply and recharge of electrical energy. The very fast transient response of the 62000D two quadrants can simulate the battery and convert according to the actual needs of the motor, offering stable voltage and allowing current recharge during braking.

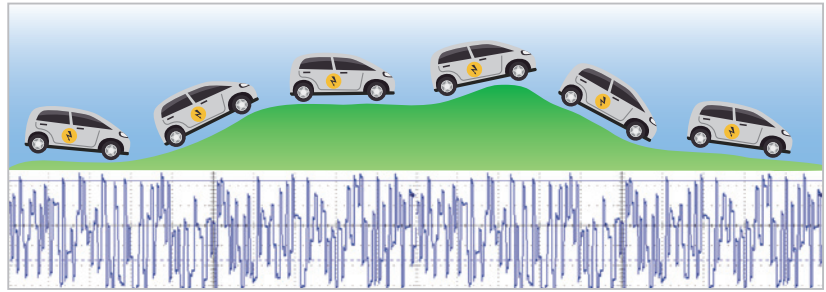

Simulation of actual driving conditions

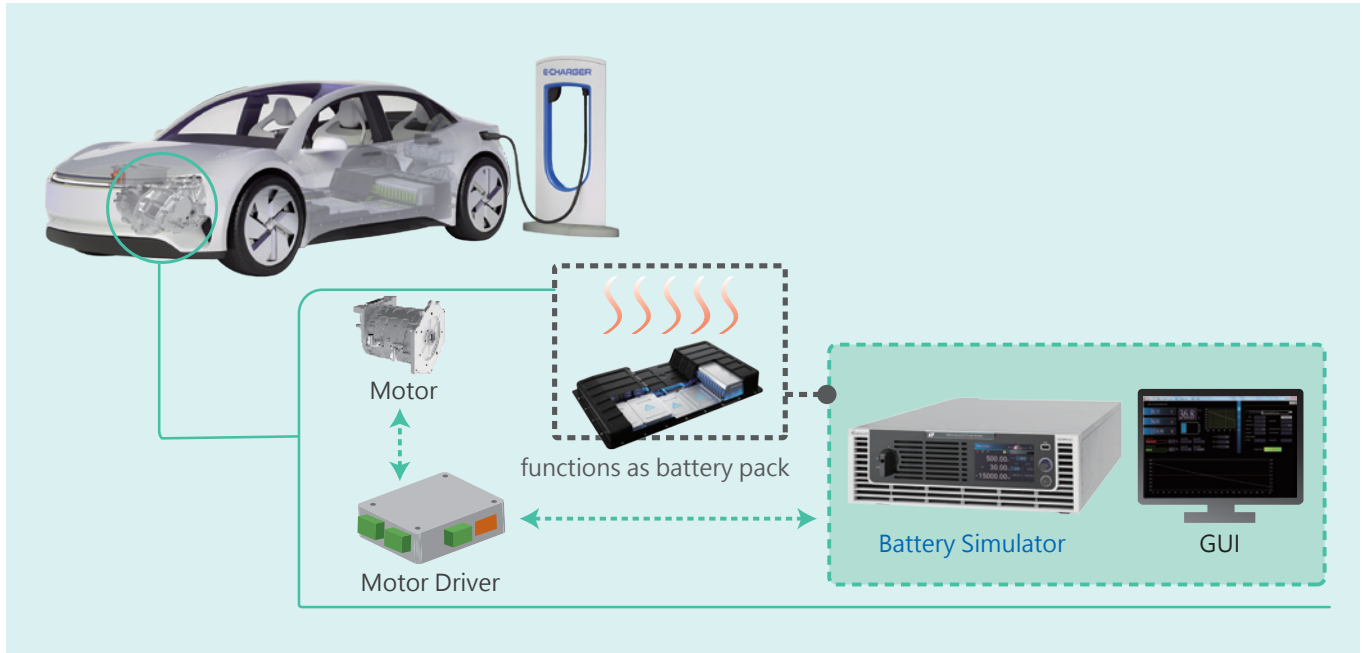

Start-stop system motor driver test application

TESTING STANDARDS LV123 AND LV 148

Along with the global energy efficiency and carbon emission reduction trends, the car industry have established technical development standards for new energy vehicles, which define tests for a variety of electric vehicles. The LV123 guidelines specify the vehicle's electrical characteristics and safety of high-voltage components, whereas the LV148 standard covers tests for electric and electronic components in 48V electrical system motor vehicles. Chroma 62000D has a high-speed CV dynamic response slope that can be controlled up to 180V/ms, which is applicable to the electrical characteristics tests of many vehicle guidelines. When combined with the Chroma Softpanel, the user can even conduct the tests at the push of a button.



BATTERY SIMULATION FUNCTION

62000D are bidirectional DC power supplies that can be charged or discharged by an external power source. Therefore, with the operation of software, the 62000D become battery simulators that can simulate operation at different capacity (SOC) or import specific battery characteristics V-I curves. It can evaluate the product under different battery capacities or with different battery characteristics. 62000D is suitable for testing various products such as BOBC, PCS, ESS or motor drivers.

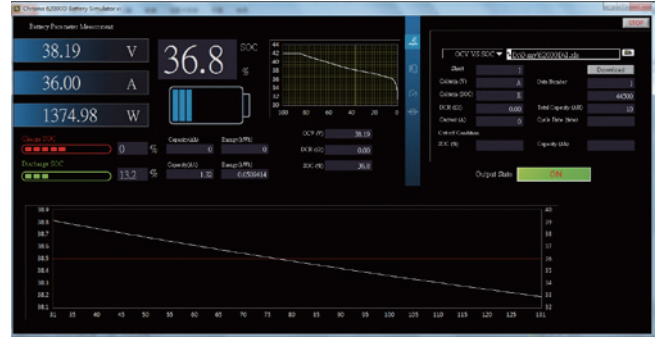

SOLAR ARRAY SIMULATION FUNCTION (OPTIONAL)

Model 62180D-1800 has a built-in EN50530 and Sandia's SAS model that allow user easily program different solar cell I-V characteristic outputs via manual or remote SCPI control. The graphical user interface SAS SoftPanel includes static&dynamic MPPT test \ shadowed I-V curve simulation \ real world weather simulation and auto run function of static&dynamic MPPT test with generate reports after finished, it is idea for PV inverter design as well as for verification testing. When high power solar array simulation is required, it is common to connect two or more power modules in parallel. The 62180D-1800 with a current range up to 40A and a voltage range up to 1800V offers a high power density envelope maximum of 18kW in a 3U package. It can easily parallel up to 30 units in a Master/Slave configuration to provide 540kW/1800V/1200A for commercial string PV inverter (15kW~500kW) testing.

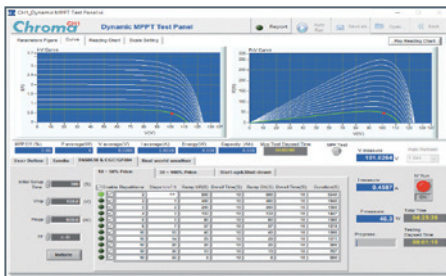

EN50530 & Sandia Dynamic MPPT Test



Static MPPT Test

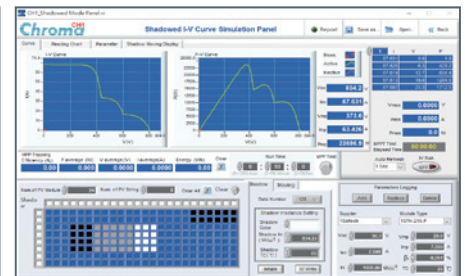

Shadow I-V Curve Simulation

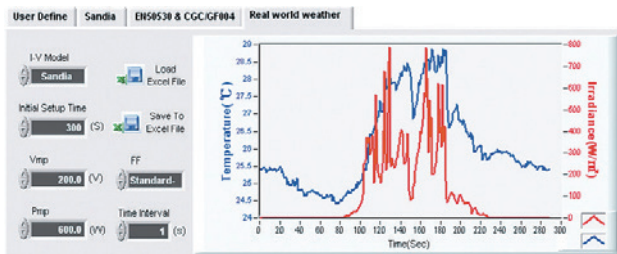

Real World Weather Simulation

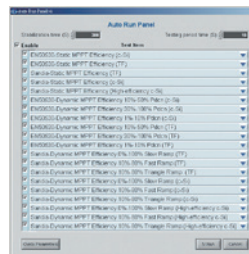

Auto Run Report

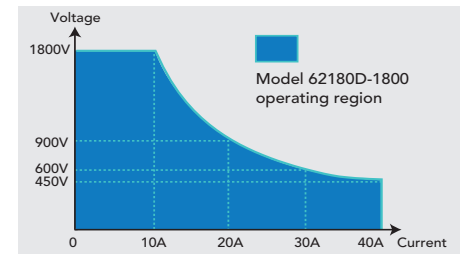

62180D-1800 Operating Region in Source Mode

SAFETY AND AC FAULT PROTECTION

Chroma 62000D bidirectional DC power supplies have energy recycling function that returns energy to the grid. The internal protection design serves to identify input voltage and frequency anomalies. When detecting any anomalies, the 62000D will automatically turn off the output to ensure safe use of the grid. The 62000D is set up with OVP, OCP, OPP, OTP, Fan Fail, and AC Fault protection circuits. AC Fault protection includes OVP, UVP, Unbalance, Freq. Error, and OCP.

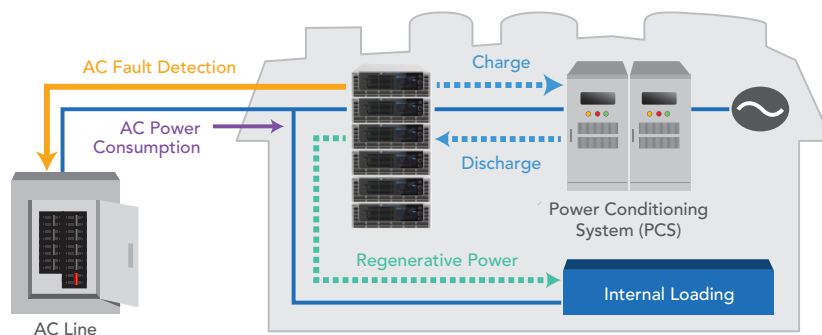

FOUR AUTO-OPERATING RANGES

Chroma's 62000D bidirectional DC power supplies include four auto-operating ranges. The 62180D-600 has an 18kW/600V/120A output and operates flexibly in various combinations as the figure below shows. Compared with the three output ranges of competitors, the 62000D can give much greater current at low voltage. This offers an even wider coverage of low voltage/high current and high voltage/low current DUTs that other DC power supplies can test. When used into a standard ATE system or on a laboratory table, one 62000D can replace multiple DC power supplies to significantly save space and costs.

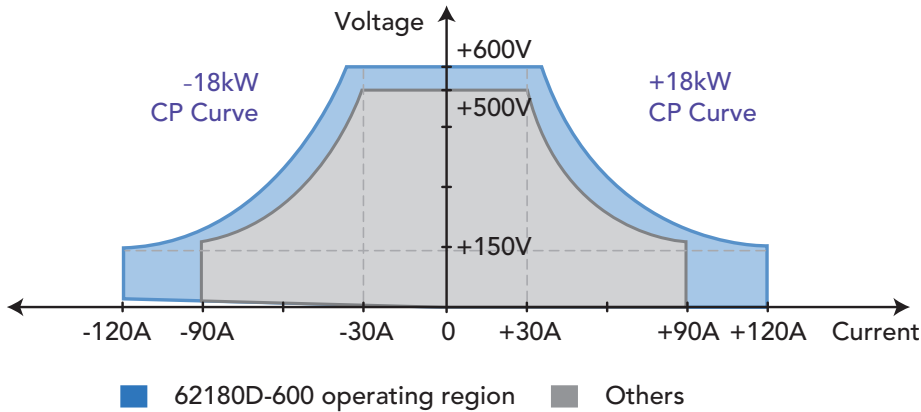

When testing high power 10kW~180kW conversion components (e.g. PCS, ESS, Charger, Inverter), users need to consider small volume, light weight, utilization rate, flexible assembly and disassembly for operation of various power systems, and influence of R&D during system failure and maintenance. The 62000D Series has a smart master/slave control mode that can connect 2 to 10 devices, enabling fast and simple series/parallel operation for use by R&D, QC, and at the production line. In this mode, the master scales values and downloads data to slave units so programming is as simple as using a single unit, and the digital current sharing is highly stable and without noise interference.

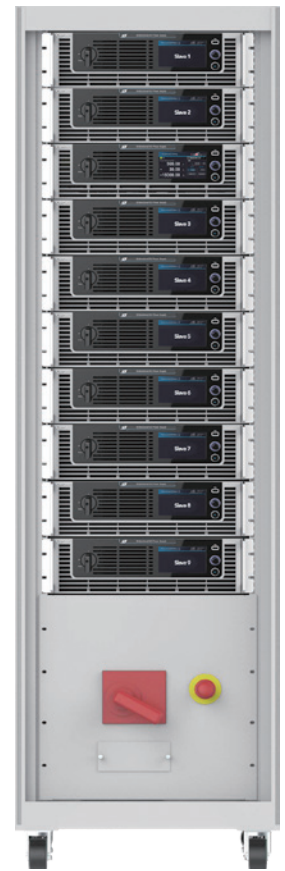

Master/slave parallel operation up to 180kW
* Call for availability

HIGH POWER SYSTEM INTEGRATION

Chroma provides high power system solution from 54kW-540kW/1800V/1200A system integration services, this power system has multiple safety protections (AC Breaker circuit breaker includes overcurrent protection, leakage current detection protection, emergency stop button device, input AC over Voltage, under voltage, OFF, UFP, system over temperature, fan failure, etc.) is suitable for long-term testing and use in R&D and production lines.



UNIVERSAL AC POWER RANGE 200~480VAC

Chroma 62000D bidirectional DC power supply is equipped with an active PFC >0.97 for low energy consumption and high conversion efficiency. Moreover, to fit the universal AC power input range, the 62000D series has a very wide input power range of three-phase 200Vac to 220Vac and 380Vac to 480Vac inputs. The user can buy one single device without having to configure it for use in other areas.

REMOTE INTERFACES

Chroma 62000D supports various remote interfaces, enabling the user to control the PC through the standard USB and LAN or optional GPIB interfaces. Moreover, the optional CAN interface as frequently used in the automobile industry is compliant with the CAN2.0 A 11-bit and CAN2.0 B 29-bit identifiers and has a V/I/P cycle time of up to 10ms.

USER-FRIENDLY INTUITIVE CONTROL INTERFACE

Chroma 62000D has a next generation human-machine control interface with an intuitive and user-friendly touch screen. Operation of the apparatus is as easy as using a smartphone, with its intelligent and convenient user interface; through icons on the touch screen, the user can complete any voltage/current settings and measurements, program sequence control settings, preview output waveforms, etc.



Control interface

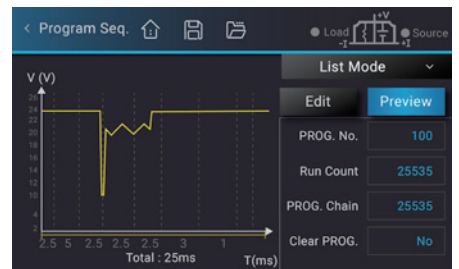
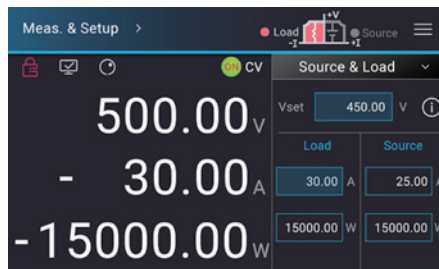
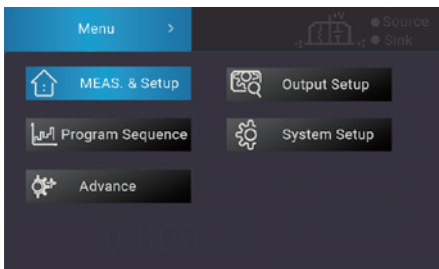

SOFTPANEL

The 62000D series can be operated from the front panel controls or from available softpanel. This user friendly software includes all functions of the 62000D series and is easy to understand and operate. The 62000D can be controlled via GPIB, USB and Ethernet interfaces for remote control and automated testing applications.



List Mode



Fixed Mode



Step Mode

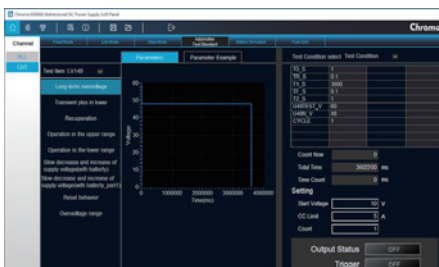

Automotive Test Standard



Battery Simulator



Fuel Cell

SPECIFICATIONS - 1 (100V & 600V Models)

Model	62060D-100	62120D-100	62180D-100	62060D-600	62120D-600	62180D-600
Source/Sink Ratings						
Source/Sink Voltage	0~100V			0~600V		
Source/Sink Current	±180A	±360A	±540A	±40A	±80A	±120A
Source/Sink Power *1	±6000W	±12000W	±18000W	±6000W	±12000W	±18000W
Min. Load Voltage (@ I Load Max.) *2	5V			30V		
Line Regulation						
Voltage	±0.01% F.S.					
Current	±0.05% F.S.					
Load Regulation						
Voltage	±0.02% F.S.					
Current	±0.1% F.S.					
Voltage Measurement						
Range	20V / 100V			120V / 600V		
Accuracy	0.05% + 0.05%F.S.					
Current Measurement						
Range	36A / 180A	72A / 360A	108A / 540A	8A / 40A	16A / 80A	24A / 120A
Accuracy	0.1% + 0.1%F.S.					
Output Noise & Ripple						
P-P (20MHz)	150 mV			420mV		
rms (Voltage)	25 mV			85mV		
rms (Current)	150mA	300mA	450mA	30mA	60mA	90mA
Programming Response Time						
Rise Time (Full Load)	10 ms			20ms		
Rise Time (No Load)	10 ms			10 ms		
Fall Time (Full Load)	10 ms			20ms		
Fall Time (No Load)	10 ms			10 ms		
Slew Rate Control						
Voltage slew rate range	0.001V/ms~ 10V/ms			0.001V/ms~60V/ms		
Current slew rate range	0.001A~10A/ms	0.001A~20A/ms	0.001A~30A/ms	0.001A~20A/ms	0.001A~40A/ms	0.001A~60A/ms
Minimum transition time (CV)	0.5ms			0.5ms		
Transient Response Time (CV)	Recovers within 500µs to ±0.75% of steady-state output for a 50% to 100% or 100% to 50% load change (1A/µs)					
Operating Mode						
Source	CC, CV, CP					
Load	CC, CP					
Source & Load *3	CC, CV, CP, CR, Ri					
Efficiency (Typical)	Source > 0.91 Sink > 0.90	Source > 0.91 Sink > 0.90	Source > 0.92 Sink > 0.90	Source > 0.91 Sink > 0.92	Source > 0.92 Sink > 0.93	Source > 0.92 Sink > 0.93
Drift (30 minutes)						
Voltage	0.04% of Vmax			0.04% of Vmax		
Current	0.06% of Imax			0.06% of Imax		
Drift (8 hours)						
Voltage	0.02% of Vmax			0.02% of Vmax		
Current	0.04% of Imax			0.04% of Imax		
Temperature Coefficient						
Voltage	0.04% of Vmax/°C			0.04% of Vmax/°C		
Current	0.06% of Imax/°C			0.06% of Imax/°C		

Note *1: When input at low voltage 200Vac~220Vac, output power rate derates to 67%; when input at high voltage 380Vac~480Vac, output power is a full 100%. (Example: 18kW derates to 12kW at 200Vac~220Vac.)

Note *2: The specification of minimum load voltage is the same when operating under source & load mode.

Note *3: For CR and Ri modes, please call for availability.

SPECIFICATIONS - 1 (100V & 600V Models)

Model	62060D-100	62120D-100	62180D-100	62060D-600	62120D-600	62180D-600
Programming & Measurement Resolution						
Voltage (Front Panel)	10 mV			10 mV		
Current (Front Panel)	10 mA			10 mA		
Voltage (Digital Interface)	0.002% of Vmax			0.002% of Vmax		
Current (Digital Interface)	0.004% of Imax			0.002% of Imax		
Voltage (Analog Interface)	0.04% of Vmax			0.04% of Vmax		
Current (Analog Interface)	0.04% of Imax			0.04% of Imax		
Programming Accuracy						
Voltage (Front Panel and Digital Interface)	0.05% of Vmax			0.05% of Vmax		
Current (Front Panel and Digital Interface)	0.2% of Imax			0.2% of Imax		
Power (Front Panel and Digital Interface)	0.3% of Pmax			0.3% of Pmax		
Voltage (Analog Interface)	0.2% of Vmax			0.2% of Vmax		
Current (Analog Interface)	0.3% of Imax			0.3% of Imax		
APG Measurement Accuracy						
Voltage (Analog Interface)	0.5% of Vmax			0.5% of Vmax		
Current (Analog Interface)	0.75% of Imax			0.75% of Imax		
Analog Interface (I/O)						
Voltage and Current Programming Inputs (I/P)	Voltage : 0~10 Vdc of F.S. Current : Source I : 0~10 Vdc of F.S. Load I : 0~10 Vdc of F.S.					
Voltage and Current Monitor Output (O/P)	Voltage : 0~10 Vdc of F.S. Current : -10~10 Vdc of F.S.					
External ON/OFF (I/P)	TTL: Active Low or High (selective)					
DC_ON Signal (O/P)	Level by user defined (Time delay=1ms at voltage slew rate of 10V/ms.)					
CV or CC Mode Indicator (O/P)	TTL Level High=CV mode ; TTL Level Low=CC mode					
OTP Indicator (O/P)	TTL: Active Low					
System Fault Indicator (O/P)	TTL: Active Low					
Safety Interlock (I/P)	Time accuracy: <100ms					
Remote Inhibit (I/P)	TTL: Active Low					
OVP Adjustment Range						
Range	0~110% programmable					
Accuracy	±1% of full scale output					
Auto Sequencing (List Mode)						
Number of Program	10					
Number of Sequence	100					
Dwell time Range	2ms~15,000s					
Trig. Source	Manual / Auto / External					
Auto Sequencing (Step Mode)						
Start Voltage	0 to full scale					
End Voltage	0 to full scale					
Run Time	hh : mm : ss.sss (00 : 00 : 00.001 to 99 : 59 : 59.99)					
Trig. Source	Auto					
Series & Parallel Operation *4	Master / save control for 3 units (Series: 2 units / Parallel: 3 units)			Master / slave control for 10 units (Series: 2 units / Parallel: 10 units)		
Input Specification						
AC Input Voltage 3-phase, 3-wire + Ground (w/o neutral)	3 Φ 200Vac~220Vac \pm 10% w/o neutral 3 Φ 380Vac~480Vac \pm 10% w/o neutral (67% output power@200~220Vac input, 100% output power@380~480Vac input)					
AC Frequency Range	47~63 Hz					
Power Factor	>0.97					
General Specification						
Maximum Remote Sense Line Drop Compensation	2% of full scale voltage per line (5% total)			2% of full scale voltage per line (4% total)		
Operating Temperature Range	0°C~40°C					
Storage Temperature Range	-25°C~70°C					
Dimension Size (HxWxD) mm	133 x 428 x 730 mm / 5.23 x 16.85 x 28.74 inch					
Weight (kg)	32.6 kg/71.9 lbs	38.8 kg/85.5 lbs	45 kg/100 lbs	30.6 kg/67.4 lbs	34.8 kg/76.7 lbs	39 kg/86.1 lbs

Note *4: For higher power >180kW~540kW, please call for availability.

* All specifications are subject to change without notice.

• Continued on next page ➡

SPECIFICATIONS - 2 (1200V & 1800V Models)

Model	62120D-1200	62180D-1200	62180D-1800
Source/Sink Ratings			
Source/Sink Voltage	0~1200V	0~1200V	0~1800V
Source/Sink Current	± 40A	± 40A	± 40A
Source/Sink Power *1	± 12000W	± 18000W	± 18000W
Min. Load Voltage (@ I Load Max.) *2	90V		
Line Regulation			
Voltage	± 0.01% F.S.		
Current	± 0.05% F.S.		
Load Regulation			
Voltage	± 0.04% F.S.		
Current	± 0.1% F.S.		
Voltage Measurement			
Range	240V /1200V	240V /1200V	360V / 1800V
Accuracy	0.05% + 0.05%F.S.	0.05% + 0.075%F.S.	0.05% + 0.05%F.S.
Current Measurement			
Range	8A / 40A	8A / 40A	8A / 40A
Accuracy	0.1% + 0.1%F.S.		
Output Noise & Ripple			
P-P (20MHz)	840mV	1260mV	1260mV
rms (Voltage)	170mV	255mV	255mV
rms (Current)	30mA	30mA	30mA
Programming Response Time			
Rise Time (Full Load)	20ms		
Rise Time (No Load)	10 ms		
Fall Time (Full Load)	20ms		
Fall Time (No Load)	10ms		
Slew Rate Control			
Voltage slew rate range	0.001V/ms~120V/ms	0.001V/ms~180V/ms	0.001V/ms~180V/ms
Current slew rate range	0.001A~20A/ms		
Minimum transition time (CV)	0.5ms		
Transient Response Time (CV)	Recovers within 500µs to ± 0.75% of steady-state output for a 50% to 100% or 100% to 50% load change (1A/µs)		
Operating Mode			
Source	CC, CV, CP		
Load	CC, CP		
Source & Load *3	CC, CV, CP, CR, Ri		
Efficiency (Typical)	Source > 0.91 Sink > 0.92	Source > 0.91 Sink > 0.90	Source > 0.92 Sink > 0.93
Drift (30 minutes)			
Voltage	0.04% of Vmax	0.06% of Vmax	0.04% of Vmax
Current	0.06% of Imax		
Drift (8 hours)			
Voltage	0.02% of Vmax	0.03% of Vmax	0.02% of Vmax
Current	0.04% of Imax		
Temperature Coefficient			
Voltage	0.04% of Vmax/°C	0.06% of Vmax/°C	0.04% of Vmax/°C
Current	0.06% of Imax/°C		

Note *1: When input at low voltage 200Vac~220Vac, output power rate derates to 67%; when input at high voltage 380Vac~480Vac, output power is a full 100%. (Example: 18kW derates to 12kW at 200Vac~220Vac.)

Note *2: The specification of minimum load voltage is the same when operating under source & load mode.

Note *3: For CR and Ri modes, please call for availability.

SPECIFICATIONS - 2 (1200V & 1800V Models)

Model	62120D-1200	62180D-1200	62180D-1800
Programming & Measurement Resolution			
Voltage (Front Panel)	100 mV	100 mV	100 mV
Current (Front Panel)	10 mA	10 mA	10 mA
Voltage (Digital Interface)	0.002% of Vmax	0.003% of Vmax	0.002% of Vmax
Current (Digital Interface)		0.004% of Imax	
Voltage (Analog Interface)	0.04% of Vmax	0.06% of Vmax	0.04% of Vmax
Current (Analog Interface)		0.04% of Imax	
Programming Accuracy			
Voltage (Front Panel and Digital Interface)	0.05% of Vmax	0.075% of Vmax	0.05% of Vmax
Current (Front Panel and Digital Interface)		0.2% of Imax	
Power (Front Panel and Digital Interface)		0.3% of Pmax	
Voltage (Analog Interface)		0.2% of Vmax	
Current (Analog Interface)		0.3% of Imax	
APG Measure Accuracy			
Voltage (Analog Interface)		0.5% of Vmax	
Current (Analog Interface)		0.75% of Imax	
Analog Interface (I/O)			
Voltage and Current Programming Inputs (I/P)		Voltage : 0~10 Vdc of F.S. Current : Source I : 0~10 Vdc of F.S. Load I : 0~10 Vdc of F.S.	
Voltage and Current Monitor Output (O/P)		Voltage : 0~10 Vdc of F.S. Current : -10~10 Vdc of F.S.	
External ON/OFF (I/P)		TTL: Active Low or High (selective)	
DC_ON Signal (O/P)		Level by user defined (Time delay=1ms at voltage slew rate of 10V/ms.)	
CV or CC Mode Indicator (O/P)		TTL Level High=CV mode ; TTL Level Low=CC mode	
OTP Indicator (O/P)		TTL: Active Low	
System Fault Indicator (O/P)		TTL: Active Low	
Safety Interlock (I/P)		Time accuracy: <100ms	
Remote Inhibit (I/P)		TTL: Active Low	
OVP Adjustment Range			
Range		0~110% programmable	
Accuracy		±1% of full scale output	
Auto Sequencing (List Mode)			
Number of Program		10	
Number of Sequence		100	
Dwell time Range		2ms~15,000s	
Trig. Source		Manual / Auto / External	
Auto Sequencing (Step Mode)			
Start Voltage		0 to full scale	
End Voltage		0 to full scale	
Run Time		hh : mm : ss.sss (00 : 00 : 00.001 to 99 : 59 : 59.99)	
Trig. Source		Auto	
Series & Parallel Operation *4		Master / slave control for 10 units. (Parallel: 10 units)	
Input Specification			
AC Input Voltage 3 phase, 3 Wire + Ground (w/o neutral)		3 Φ 200Vac~220Vac \pm 10% w/o neutral 3 Φ 380Vac~480Vac \pm 10% w/o neutral (67% output power@200~220Vac input, 100% output power@380~480Vac input)	
AC Frequency Range		47~63 Hz	
Power Factor		>0.97	
General Specification			
Maximum Remote Sense Line Drop Compensation		2% of full scale voltage per line (4% total)	
Operating Temperature Range		0°C~40°C	
Storage Temperature Range		-25°C~70°C	
Dimension Size (HxWxD) mm		133 x 428 x 730 mm / 5.23 x 16.85 x 28.74 inch	
Weight (kg)	34.8 kg/76.7 lbs	39 kg/86.1 lbs	39 kg/86.1 lbs

Note *4: For higher power >180kW~540kW, please call for availability.

* All specifications are subject to change without notice.

PANEL DESCRIPTION

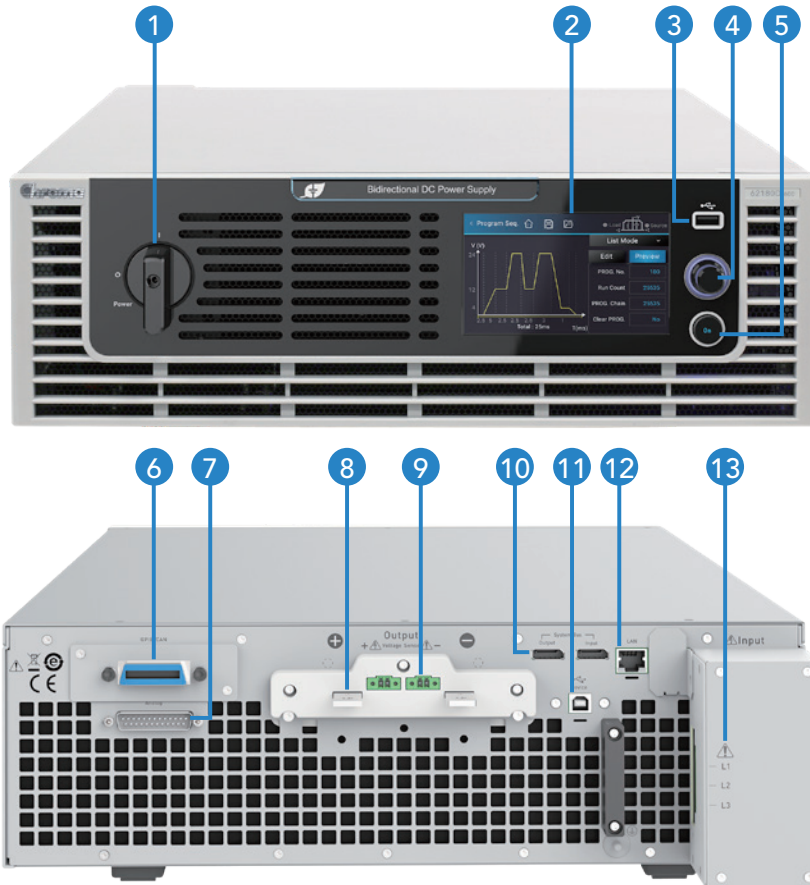

1. **POWER Switch**
2. **TFT Control Interface**
Displays: measurements, setup, control, and status
3. **USB HOST** (not yet supported)
Programming: program fetching, data downloading, firmware updates, etc.
4. **Pushable Rotary Switch**
Rotate to edit screen and set values; after configuration, push to confirm input
5. **OUTPUT ON Key**
Press the ON key: light indicates Output ON, dark indicates Output OFF

6. **GPIB & CAN Interfaces Shared Slot** (choose one)
7. **Analog Programming Interface**
For analog level to program and monitor output voltage & current
8. **DC Output Terminal**
9. **Remote Sense Terminal**
10. **Current Sharing Terminal**
Connect the cable to slave unit
11. **USB Interface** (standard)
12. **LAN Interface** (standard)
13. **AC Input Terminal**

ORDERING INFORMATION

62000D Series : Programmable Bidirectional DC Power Supply
 62060D-100 : Programmable Bidirectional DC Power Supply 100V/180A/6kW
 62120D-100 : Programmable Bidirectional DC Power Supply 100V/360A/12kW
 62180D-100 : Programmable Bidirectional DC Power Supply 100V/540A/18kW
 62060D-600 : Programmable Bidirectional DC Power Supply 600V/40A/6kW
 62120D-600 : Programmable Bidirectional DC Power Supply 600V/80A/12kW
 62180D-600 : Programmable Bidirectional DC Power Supply 600V/120A/18kW
 62120D-1200 : Programmable Bidirectional DC Power Supply 1200V/40A/12kW
 62180D-1200 : Programmable Bidirectional DC Power Supply 1200V/40A/18kW
 62180D-1800 : Programmable Bidirectional DC Power Supply 1800V/40A/18kW

A620039 : GPIB Interface
 A620045 : CAN Interface
 A620046 : 62000D Softpanel

* B620003: Optional Solar Array Simulation Function for model 62180D-1800 (Factory installation)

* Call for availability

Get more product & global distributor information in Chroma ATE APP



Search Keyword

62000D

HEADQUARTERS
 CHROMA ATE INC.
 88 Wenmao Rd.,
 Guishan Dist.,
 Taoyuan City
 333001, Taiwan
 T +886-3-327-9999
 F +886-3-327-8898
 www.chromaate.com
 info@chromaate.com

U.S.A.
 CHROMA SYSTEMS
 SOLUTIONS, INC.
 19772 Pauling,
 Foothill Ranch,
 CA 92610
 T +1-949-600-6400
 F +1-949-600-6401
 www.chromausa.com
 sales@chromausa.com

EUROPE
 CHROMA ATE EUROPE B.V.
 Morsestraat 32, 6716 AH
 Ede, The Netherlands
 T +31-318-648282
 F +31-318-648288
 www.chroma.eu.com
 salesnl@chroma.eu.com

CHROMA GERMANY GMBH
 Südtiroler Str. 9, 86165,
 Augsburg, Germany
 T +49-821-790967-0
 F +49-821-790967-600
 www.chroma.eu.com
 salesde@chroma.eu.com

JAPAN
 CHROMA JAPAN
 CORP.
 888 Nippa-cho,
 Kouhoku-ku,
 Yokohama-shi,
 Kanagawa,
 223-0057 Japan
 T +81-45-542-1118
 F +81-45-542-1080
 www.chroma.co.jp
 info@chroma.co.jp

KOREA
 CHROMA ATE
 KOREA BRANCH
 3F Richtogether
 Center, 14,
 Pangyoyeok-ro 192,
 Bundang-gu,
 Seongnam-si,
 Gyeonggi-do
 13524, Korea
 T +82-31-781-1025
 F +82-31-8017-6614
 www.chromaate.co.kr
 info@chromaate.com

CHINA
 CHROMA ELECTRONICS
 (SHENZHEN) CO., LTD.
 8F, No.4, Nanyou Tian
 An Industrial Estate,
 Shenzhen, China
 T +86-755-2664-4598
 F +86-755-2641-9620
 www.chroma.com.cn
 info@chromaate.com

SOUTHEAST ASIA
 QUANTEL PTE LTD.
 (A company of Chroma Group)
 25 Kallang Avenue #05-02
 Singapore 339416
 T +65-6745-3200
 F +65-6745-9764
 www.quantel-global.com
 sales@quantel-global.com